

greater degree of steric hindrance to bond formation at the tertiary α -carbon in transition state 1 as compared to the secondary α -carbon in transition state 2.

The ozonation of ethyl ethoxyacetate is shown in Scheme II.

The acid indicated as arising from reaction 3 was measured by titration, but the identity of the acid as

ethoxyacetic acid was not established. However, cleavage of the ethyl ester group is a logical source for this acid, since ethyl acetate gave a very similar acid titer under similar ozonation conditions (4.2 *vs.* 2.9 mmoles).

A study of the reaction of polyethers with ozone is still in progress and will be reported shortly.

[CONTRIBUTION FROM CENTRAL RESEARCH DIVISION, AMERICAN CYANAMID COMPANY, STAMFORD, CONN.]

The Nature of Electrogenative Hydrogenation

BY STANLEY H. LANGER¹ AND HENRY P. LANDI

RECEIVED JANUARY 1, 1964

The electrogenerative hydrogenation process is characterized and its limitations are discussed. In this process, hydrogen and substrate are separated by an electrolyte acting as a barrier phase. Hydrogen ionizes at an anode and is transported through the electrolyte to a cathode. Generated electrons flow through an external circuit to the cathode where they combine with transported hydrogen ions and substrate to give hydrogenated product. Favorable thermodynamic factors drive the reaction and generate current. It is shown that hydrogen ion transport in the electrogenerative process is not caused by a simple hydrogen concentration cell effect. The hydrogenation reaction is found to be essentially stoichiometric for olefins with respect to reactants and current generated. Reactants should not be soluble in the barrier electrolyte phase. With platinum black electrode catalyst at room temperature, the electrogenerative hydrogenation process does not proceed readily with acetylene substrate. However, since reactants are separated, electrogenerative hydrogenation is advantageous when a chemical hydrogenation, such as reaction of hydrogen with cyclopropane, is inhibited because of adsorption of hydrogen on the catalyst surface.

In an earlier communication² we reported a new technique for electrochemical hydrogenation which was called *electrogenative hydrogenation*. With an acidic electrolyte acting as a barrier phase separating hydrogen and unsaturated hydrocarbon or other substrate, hydrogen gas is converted to hydrogen ions at an anode. The generated electrons flow through an external circuit to a cathode where they are consumed in reaction with substrate and transported hydrogen ions to give hydrogenated product. In base solution, electrode reactions are different (*vide infra*), but the net reaction is hydrogenation. Favorable thermodynamic factors drive the hydrogenation reaction. The purpose of this paper is to characterize the electrogenerative hydrogenation process and to indicate some of its limitations as well as advantages and applications.

Reactions in an aqueous electrolyte barrier phase may be represented as

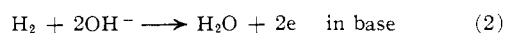
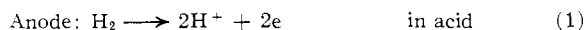

Cathode:

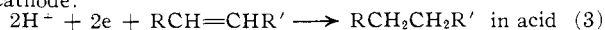

Experimental

A circuit diagram of ancillary apparatus used with an electrogenerative hydrogenation cell is shown in Fig. 1. The variable external resistor and cell internal resistance control the current drawn from the cell and, therefore, the potential at the hydrogenating electrode.

The platinum black-polytetrafluoroethylene electrodes were prepared as described previously³⁻⁵ and generally were supported

on stainless steel or tantalum screen. Electrodes may also be made with platinum black and polyethylene. In the preparation of these electrodes, heavy catalyst loadings are not particularly desirable since they may interfere with gas diffusion to or from the electrodes and electrolyte.

Polarization is very slight at the hydrogen electrode (anode) with the currents used in this work, and practically all of the polarization observed^{2,4} is at the hydrogenating electrode (cathode).

The internal construction of the electrogenerative hydrogenation cell used here is essentially the same as that described previously for hydrogen purification⁴ and electrogenerative hydrogenation.² Electrode exposed area was 4.9 cm.². All experiments were done at a temperature of 25°.

The experiments reported are typical and sampled from a number of similar experiments. The cell and associated apparatus which were found to be most useful are shown in Fig. 2. The plastic face plates were fitted with inlet and outlet stainless steel tubing so that cell operation could be studied under continuous flow conditions.

The face plates were fitted with additional outlets to hydrogen and hydrocarbon reservoirs so that inlet and outlet vents could be closed and the apparatus operated under static conditions while changes in gas volume were observed. Gas sample bulbs were incorporated in the apparatus on both sides of the cell as shown in Fig. 2 so that representative product samples could be obtained for mass spectral analyses.⁶ A magnetic stirrer was incorporated in the gas circulation loop as shown to circulate the gas and to ensure thorough mixing of substrate with hydrogenated product. A buret and mixing chamber with provision for gas transfer were also included on the hydrogenating side of the cell to ensure that all substrate was exposed to the hydrogenating electrode. The gases were stored and manipulated over water.

Preparatory to each run, hydrogen was passed over both electrodes while the electrogenerative cell was shorted. A preliminary polarization curve was then run with hydrogen and olefin or other substrate. The indicated open circuit potential is the one achieved after about 0.5 hr. on open circuit after at least one previous polarization run. The change in potential then is less than 2 mv./5 min. This open circuit potential is reproducible to within 0.01-0.02 v. The polarization data represent steady-state conditions (with gases flowing) which are achieved after about 3 min. at specified current.

others, are commercially available from American Cyanamid Co., attn. A. B. Swift, Wayne, N. J.

(6) We thank Mr. A. Struck for these analyses.

(1) Correspondence should be addressed to the Department of Chemical Engineering, University of Wisconsin, Madison, Wis.

(2) S. H. Langer and H. P. Landi *J. Am. Chem. Soc.*, **85**, 3043 (1963).

(3) (a) G. V. Elmore and H. A. Tanner, *J. Electrochem. Soc.*, **108**, 69 (1961); (b) W. T. Grubb, Proc. 16th Ann. Power Sources Conf. (PSC Publications Committee, P. O. Box 891, Red Bank, N. J.), pp. 31-34.

(4) S. H. Langer and R. G. Haldeman, *Science*, **142**, 225 (1963).

(5) The 9 mg./cm.² platinum on tantalum screen electrodes, as well as

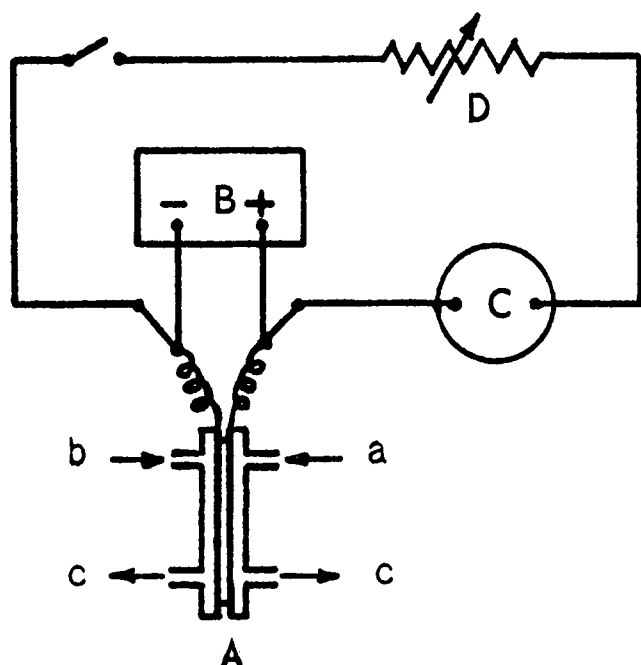

Fig. 1.—Circuit diagram of ancillary apparatus to hydrogenation cell: A, cell; B, potentiometer; C, ammeter; D, variable resistor; a, olefin inlet; b, hydrogen inlet; c, gas outlets.

Cell internal resistance measurements were made with an Industrial Instruments conductivity bridge 16B2 or a Keithley 502 milliohm meter while hydrogen flowed over both electrodes. Correction for voltage loss owing to cell internal resistance was generally applied since this gave the true potential of the cells, obtained for a given current, and is independent of cell internal resistance. Where direct comparisons are made between two different unsaturated gases, the same cell was used generally without dismantling. The appropriate side of the cell was flushed with nitrogen and the second gas, and a number of polarization runs were made with the second gas flowing through the system before reported data were obtained.

For static runs involving analysis of products and the determination of coulometric data, polarization runs were first made with the system under flow conditions. The gas reservoir burets and the rest of the system were then flushed with appropriate reacting gases and the system was sealed under steady load conditions. On the hydrogenating side, gases were transferred from the buret to the mixing chamber occasionally to ensure uniformity of composition. Near the ends of runs when substrate was almost completely hydrogenated, voltages and currents tended to decrease. An electronic integrator⁷ was useful in this latter period when current and voltage were not steady. Otherwise, numerical integration was satisfactory with occasional readings of current, voltage, and gas volumes at varying intervals of 15 to 5 min. as required.

Results and Discussion

As we indicated earlier,² and as will be illustrated here, the electrolyte barrier phase may vary over a wide range of materials. However, it is clear that if the favorable thermodynamic driving force for electrogenerative hydrogenation is to be maintained, neither of the reactants should be significantly soluble in the electrolyte phase. When filter paper saturated with 2 *N* sulfuric acid was used in a static run with hydrogen and ethylene, open circuit voltage fell from 0.49 to 0.18 v. in 15 min. Also, the volume of ethylene decreased steadily. This does not occur to any significant extent with other electrolyte phases. Mass spectral analysis confirmed the presence of a large quantity of ethane, well above the amount calculated from current generated, on the hydrogen side of the ap-

(7) A. J. Bard, *Anal. Chem.*, **34**, 1181 (1962).

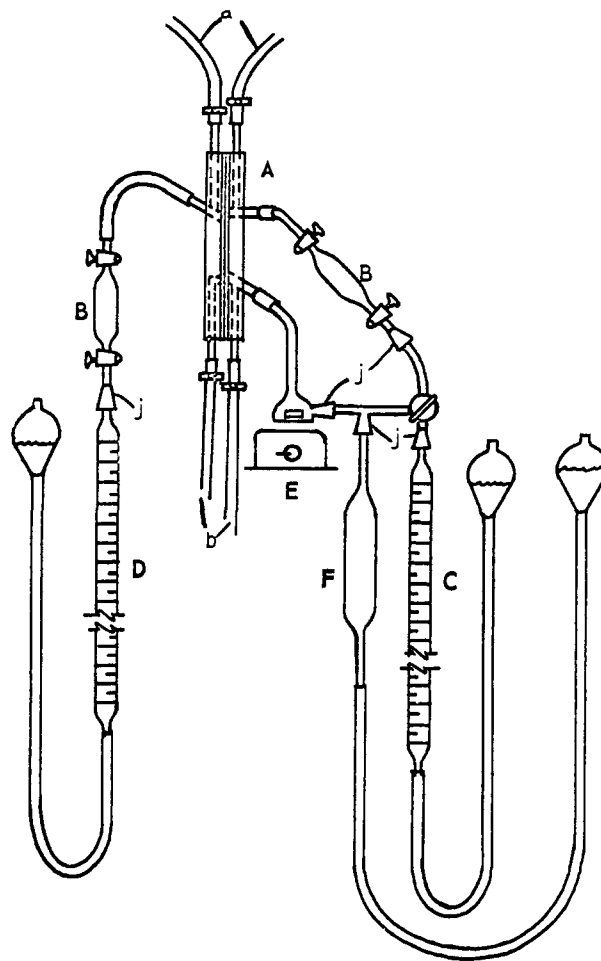

Fig. 2.—Electrogenerative hydrogenation cell with provision for static operation studies: A, cell; B, gas sampling bulbs; C, buret, 25 ml.; D, buret, 100 ml.; E, magnetic stirrer; F, gas mixing chamber; a, gas inlets; b, gas outlets; j, 10/30 ground glass joints.

paratus. Thus, it was evident that chemical hydrogenation owing to ethylene migration through the electrolyte to the hydrogen compartment predominated over the electrogenerative process.

As might be expected,⁸ the electrogenerative hydrogenation process takes place using electrolytes varying over a wide range of pH; results for 1 *N* *p*-toluenesulfonic acid are compared with results for 23% potassium hydroxide in a free electrolyte cell (0.25 in. in thickness) with propylene in Fig. 3. Propane was found to be the product with both electrolytes. The current, of course, is a measure of the rate of hydrogen consumption⁹ and, therefore, rate of hydrogenation. Under our experimental conditions, 1 ml. of H₂ ≈ 128 ma.-min. From IR_{int} corrected polarization curves, rates of hydrogenation can be compared at any given potential relative to a hydrogen electrode. This has some advantage over a previously described controlled potential coulometric technique where rate of electrochemical hydrogenation could only be compared at a single potential.⁹ IR_{int} uncorrected curves are also given in Fig. 3, and it can be seen that power losses owing to internal resistance (R_{int}) are relatively small in the lower current ranges.

(8) F. Beck and H. Gerischer, *Z. Elektrochem.*, **65**, 504 (1961).

(9) P. S. Farrington and D. T. Sawyer, *J. Am. Chem. Soc.*, **78**, 5536 (1956).

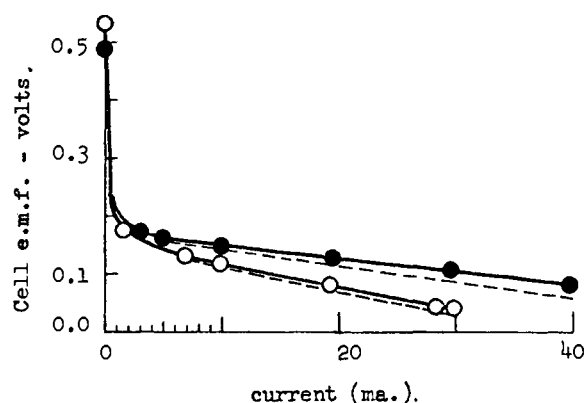

Fig. 3.—Electrogenerative hydrogenation of propylene in a free electrolyte cell. Catalyst, platinum black (9 mg./cm.²): ●, 1 *N* *p*-toluenesulfonic acid electrolyte; ○, 23% KOH electrolyte; broken curves, not corrected for internal resistance (measured working voltage).

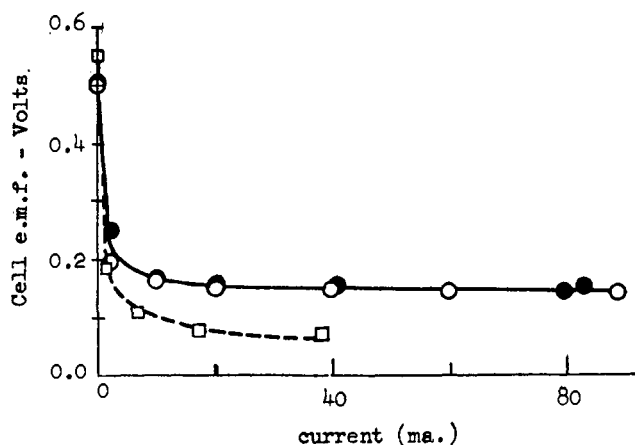
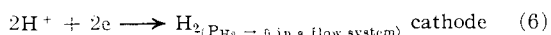
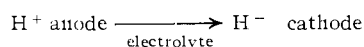
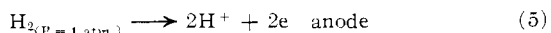

Fig. 4.—Electrogenerative hydrogenation; catalyst, platinum black (9 mg./cm.²) on tantalum screen; electrolyte, 1 *N* HBF₄ on 5 sheets of filter paper; $R_{int} = 0.49$ ohms: ●, ethylene; ○, propylene; □, nitrogen flowing through cathode side of cell.

In Fig. 4, polarization curves for ethylene and propylene are compared for thin platinum black electrodes and a fluoroboric acid electrolyte. It is seen that rates of hydrogenation are about the same over a fairly wide range of potential, at least for the electrodes used. When a palladium black electrode was used in the olefin compartment of the cell, there was considerable difference in a polarization for ethylene and propylene at given currents.¹ In Fig. 4, a polarization curve is also shown for nitrogen flowing at a rapid rate on the olefin side of the electrogenerative cell. Under these conditions, hydrogen is transported as a result of a concentration gradient. A concentration cell exists¹⁰ which might be represented by



Rate of hydrogen transfer (as hydrogen ion) will be dependent on nitrogen flow and removal of hydrogen from the cathode. It is apparent from Fig. 4 that potential at a given current is appreciably less than when olefin is present. From the polarization curve,

(10) For example, see G. M. Barrow, "Physical Chemistry," McGraw-Hill Book Co., Inc., New York, N. Y., 1961, p. 605; E. A. Moelwyn-Hughes, "Physical Chemistry," 2nd Ed., Pergamon Press, London, 1961, p. 1095.

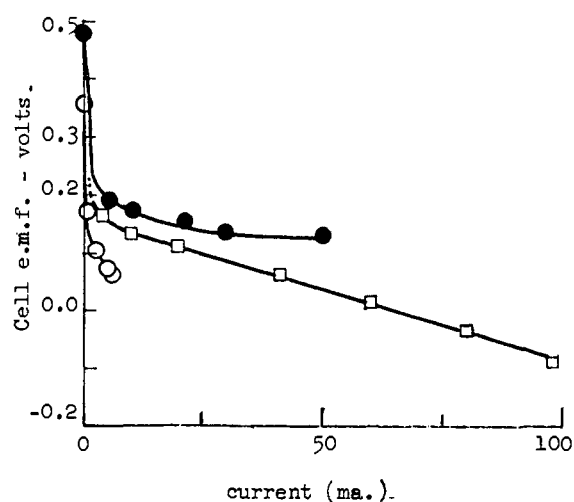

Fig. 5.—Electrogenerative hydrogenation; catalyst, platinum black (9 mg./cm.²) on tantalum screen; electrolyte, 6 *N* H₃PO₄ on 5 sheets of filter paper; $R_{int} = 1.18$ ohms: ●, propylene; □, propylene with impressed voltage (cathode potential); ○, acetylene.

one can rule out a mechanism for electrogenerative hydrogenation involving the transport of hydrogen gas as a result of a concentration cell effect which is followed by catalytic chemical hydrogenation. Furthermore, it is apparent that it is possible from potential and current values to distinguish between hydrogen ion transport from concentration cell effects and hydrogen ion transport due to electrogenerative hydrogenation in a flow system.

Some measure of the chemical hydrogenating catalytic properties of the platinum electrodes, used with propylene, was obtained from the following experiment. The electrogenerative cell was connected in the usual manner except that no electrical connections were made. The buret, C of Fig. 2, was filled with a slight (3%) excess of hydrogen (~24 ml.) and isolated from the rest of the apparatus. The glass circulating system was then filled with propylene. The buret stopcock was then opened and the gases mixed in the hydrocarbon side in the usual way so that they passed over the catalytic electrode. Normal chemical hydrogenation took place. Reaction was 97% complete in 9 min. While electrogenerative hydrogenation is generally slower, its rate can be regulated by both electrolyte resistance and resistance of the external circuit.

When hydrogen and unsaturate are placed in the electrogenerative cell in separate compartments and the system is held at open circuit, no hydrogenation is observed.

The practical operating potential at the hydrogenating electrode is limited by the IR_{int} loss of the electrolyte phase and, where this is considerable, it can be compensated for with an external power source. The consequences of such compensation are illustrated by a polarization curve of Fig. 5 where the electrolyte is filter paper saturated with phosphoric acid. As is shown, current increases with the decrease in potential of the electrode on the olefin side relative to the hydrogen electrode. The electrode on the olefin side of the electrogenerative cell eventually can be made negative relative to the hydrogen electrode and hydrogen is then pumped through the electrolyte⁴ and begins to accumulate as gas on the olefin side without hydrogenation.

This is signaled immediately by an increase in volume, under static conditions, in the reservoir buret.

If electrogenerative hydrogenation could be made quantitative, application as a coulometric analytical technique for olefins, or a mixture of olefins and other materials, might also be practical. Some typical results obtained with this objective as well as a study of the quantitative aspects of the reaction are shown in Table I.

TABLE I

QUANTITATIVE STUDY OF ELECTROGENERATIVE HYDROGENATION^a

Hydrogen side		Propylene side
68.7 ml.	Gas volumes before	46.7 ml.
	Analysis after reaction completed	
21.2 ml. H ₂		46.1 ml. C ₃ H ₆ = 352 coulombs
0.07 ml. C ₃ H ₈		1.9 ml. H ₂ = 14 coulombs
		Expected coulombs = 366

Observed coulombs generated = 356

^a Electrolyte, 1 N HBF₄ on 5 sheets of filter paper; platinum black catalyst.

The results of Table I and similar experiments indicate that the electrogenerative hydrogenation is essentially quantitative, especially since gas analysis errors are of the order of 1 or 2%. The experiment lasted 3 hr. and was initiated at a constant current of about 50 ma. and 0.12 v. After about one-half the time had elapsed current and voltage began to fall. Gases were transferred occasionally from the buret to the mixing chamber on the hydrocarbon side to ensure electrode exposure. While coulombic integration was performed manually for this experiment, in other experiments an electronic integrator⁷ was successfully employed. The completion of hydrogenation was indicated by a significant increase in gas volume, 0.1 ml./2 min. in the olefin compartment of the cell. The voltages and currents near the end of the experiment were so low, 12 ma. at 0.04 v., that the electrogenerative process could not be distinguished from concentration cell transport with voltage and current readings. Repeated experiments using filter paper saturated with various acids have shown that there may be some small amount of hydrogen gas transport, owing to slight solubility in the electrolyte, through such electrolyte phases. This is indicated by a slight excess of calculated coulombs over observed since this type of transport generates no current. However, the difference is seldom large, and probably could be minimized further if desired. With some refinement then, it would seem that electrogenerative hydrogenation could be adapted to analytical use because of its essentially quantitative nature.

The form of the thermodynamic correction to the reversible thermodynamic potential, E° , for a cell is well known and would apply to a cell operating on hydrogen

$$-\frac{RT}{n\mathcal{F}} \ln \frac{P_{\text{propane}}}{P_{\text{H}_2}P_{\text{propylene}}} \quad (7)$$

and propylene if the cell were reversible. P 's represent pressures of the indicated gases, \mathcal{F} is the Faraday, and n is the number of electrons involved in the hydrogenation reaction. On this basis, it would be expected that the use of mixtures of hydrogen and an inert gas would not have a profound effect on open circuit potentials and operating potentials if diffusion effects could be eliminated. Unfortunately, the indeterminate nature of the open circuit potential,² 0.01-

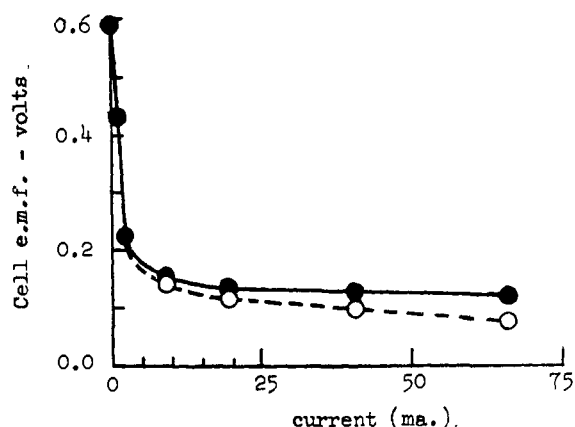

Fig. 6.—Electrogenerative hydrogenation of cyclopropane; catalyst, platinum black (9 mg./cm.²); electrolyte, 1 N HBF₄ on 5 sheets of filter paper; $R_{\text{int}} = 0.64$ ohms; broken curve, measured working voltage.

0.02 v., makes it difficult to draw conclusions when a mixture of gas such as 40% H₂, 60% N₂ is used as a source of hydrogen. However, it is possible to compare operating potentials under load. When this was done with propylene and fluoroboric acid electrolyte in a manner similar to the propylene run of Fig. 4, it was found that cell operating potential was reduced 0.013–0.014 v. in the range of 10–80 ma. The calculated potential correction from expression 7 is 0.012 v. The decrease in potential may also be regarded as caused by a change in potential of the hydrogen electrode alone, resulting in a total loss of cell potential. Since the effect of the use of dilute hydrogen mixtures is of the order predicted and not large, it is possible to use such mixtures for electrogenerative hydrogenation if desired.

In Fig. 5, polarization curves for acetylene and ethylene are also compared. Difficulty in hydrogenating acetylene with platinum catalyst at low hydrogen pressures is well established,¹¹ presumably because of strong acetylene surface adsorption. Similar difficulty with the electrogenerative process is observed. When a cell was operated under static conditions over a period of 3 hr. at about 0.04 v. and 4 ma. to 12% hydrogenation, product was ethylene, ethane, and hydrogen in the approximate ratio of 2:1:1. It would seem possible that there are acetylene catalysts which are not as readily poisoned as the one used here. Further control of product might be established through potential as well as catalyst.

While the hydrogenation of olefins takes place faster chemically compared with the electrogenerative process, there are situations where it might be expected that the electrogenerative process would be faster owing to elimination of a kinetic complication because of excessive adsorption of one of the reactants. The hydrogenation of cyclopropane to propane is an example of this.¹² It is believed that this reaction is slowed at room temperature because hydrogen is preferentially adsorbed on the catalyst surface so that cyclopropane cannot readily approach to partake in the catalytic hydrogenation process. In the electrogenerative process, presumably no hydrogen exists on the hydrocar-

(11) G. C. Bond "Catalysis by Metals," Academic Press, Inc., New York, N. Y., 1962, Chapter 12; "Advances in Catalysis," Vol. 3, P. H. Emmett, Ed., Reinhold Publishing Corp., New York, N. Y., 1955, Chapter 4.

(12) Ref. 11, pp. 271–274; J. Newham, *Chem. Rev.*, **63**, 123 (1963).

bon side as a gas. A polarization curve for cyclopropane is shown in Fig. 6, and it can be seen that it hydrogenates readily. A static run was also attempted with cyclopropane in a manner similar to the experiment used to obtain the data of Table I. Reaction was initiated at 0.1 v. and about 35 ma. After 4 hr., the operating cell voltage fell from 0.08 to 0.035 v. and volume began to increase in the cyclopropane compartment signalling the transfer of hydrogen. Mass spectral analysis showed the hydrogenation to be 89% complete and hydrogen present. It appears that some hydrogen was transferred (no more than 0.3 ml.) to the cyclopropane chamber because of concentration cell effects and this was sufficient to terminate the hydrogenation reaction. A comparable chemical hydrogenation experiment was performed in the apparatus of Fig. 2 by

first filling the buret, C, with hydrogen and proceeding as described for propylene. Hydrogen was consumed (from volume measurements) at the rate of 0.02 ml./min. This was less than one-tenth of the rate of the comparable electrogenerative process.

It appears, then, that electrogenerative hydrogenation is useful for studying mechanisms of conventional catalytic hydrogenation as well as electrochemical hydrogenation. Since open circuit potentials can also be measured,² it is possible to study olefin-metal interactions with regard to metal and olefin type.² Measurement of hydrogenation rate at given potentials provides additional information on surface interaction, especially poisoning. Thus, electrogenerative hydrogenation provides a new and novel approach to the study of electrode reactions and mechanisms.

[CONTRIBUTION FROM THE NATIONAL INSTITUTE OF ARTHRITIS AND METABOLIC DISEASES, NATIONAL INSTITUTES OF HEALTH, BETHESDA, MARYLAND 20014]

New Methods for Nonenzymatic Peptide Cleavage. Electrolytic, Differential, and Solvolytic Cleavage of the Antibiotic Cyclopeptide Rufomycin¹

BY H. IWASAKI² AND B. WITKOP

RECEIVED APRIL 4, 1964

The antibiotic cycloheptapeptide rufomycin A contains the following "bifunctional" amino acids possessing reactive centers which are amenable to cleavage of adjacent peptide groups: 3-nitrotyrosine, N,4-dimethylglutamic- γ -semialdehyde, Δ^4 -norleucine (2-amino-4-hexenoic acid), and a substituted tryptophan. The following new principles for selective cleavage of peptide bonds were elaborated: (i) electrolytic cleavage of the 3-nitrotyrosyl bond resulted in liberation of up to 38% of the adjacent alanine NH₂-terminal; (ii) solvolytic cleavage of the O-mesylate of O-methyl-dihydro-rufomycin A (VII) resulted in 53% selective cleavage to *seco*-O-methyl-dihydro-rufomycin A- δ -lactone (XI) with release of the adjacent leucyl unit; (iii) differential oxidation with N-bromosuccinimide cleaved selectively the peptide bond next to tryptophan and dehydronorleucine, when 3-nitrotyrosine was protected by O-methylation—this twofold cleavage with NBS released a novel substituted (5-bromo)spirodioxindole lactone XX characterized as its DNP derivative and convertible by the action of mineral acid to the known spiro-lactone XXI from DNP-tryptophan; (iv) differential oxidative cleavage with bromocarbamide cleaved only next to tryptophan but not dehydronorleucine; and (v) oxidative cleavage of DNP-*seco*-O-methyl-dihydro-rufomycin XI by NBS yielded the dipeptide DNP-leucyl-2-amino-4-hydroxy-5-bromohexanoic acid lactone (XXII). Rufomycin A is conveniently purified and isolated as the sodium borohydride reduction product, dihydro-rufomycin A, which readily crystallizes from ethanol.

Homogeneity and Purification of Rufomycin A.—Rufomycin A is a cyclic peptide antibiotic specifically active against Mycobacteria including the strains resistant to isonicotinic acid hydrazide, streptomycin, and kanamycin. It was isolated from the culture of a *Streptomyces* strain together with the less active rufomycin B. Both antibiotics (I, II) are cyclic heptapeptides.³

Crude rufomycin A was obtained as a yellow amorphous powder by evaporation of the solvent from the mother liquor of rufomycin B which crystallized first from ethanolic solution.

The homogeneity of crude rufomycin A was studied by thin layer chromatography on silica gel G. Among many solvent systems, benzene-dimethylformamide-acetone (76:4:20) and benzene-methanol-acetic acid (95:10:5) gave a satisfactory two-dimensional thin

layer chromatogram. Crude rufomycin A thus contained at least one major and three minor components.

For the purification of crude rufomycin A, silica gel column chromatography with benzene-methanol (95:5) and benzene-ethanol (95:5) were promising but not good enough for preparative purposes. Good separation was achieved by the application of gradient elution of 2 to 7% methanol in benzene. Crude rufomycin A consists of five components. Component I is identical with pure rufomycin B. Component II, as yet unknown, is present as an impurity both in rufomycin A and B. From 500 mg. of crude rufomycin A, 148 mg. of the main component (III) was isolated. The four components II, III, IV, and V all contain a group sensitive to reduction by sodium borohydride. This group is not present in rufomycin B (I) according to the study of the reduction with sodium borohydride by thin layer chromatography.

Convenient Purification of Rufomycin A as the Dihydro Derivative.—Rufomycin A contains 1 mole of N,4-dimethylglutamic acid γ -semialdehyde and is reduced by sodium borohydride to dihydro-rufomycin A (III). The R_f value of the main component of crude dihydro-rufomycin A is remarkably different from

(1) Presented in part at the IUPAC Symposium on the Chemistry of Natural Products, Kyoto, Japan, April, 1964; cf. H. Iwasaki, Y. Fujita, J. Ueyanagi, and B. Witkop, Abstracts, p. 172 (1964).

(2) Associate in the Visiting Program of the USPHS, 1963-1964.

(3) (a) J. Ueyanagi, M. Fujino, T. Kamiya, H. Iwasaki, A. Miyake, and S. Tatsuoka, presented before the 6th Symposium of the Chemistry of Natural Products, Kyushu University, Japan, Oct. 17, 1963. (b) While this investigation was in progress the similarity and eventual identity of rufomycin and its congeners with the ilamycins became apparent through the studies of H. Umezawa and his group; cf. T. Takita and H. Naganawa, *J. Antibiotics (A)*, **16**, 246 (1963).